



COMMERCIAL QUICK REFERENCE

PROVO CITY POWER STANDARDS SPECIFICATIONS SUBJECT TO CHANGE WITHOUT NOTIFICATION

ELECTRICAL ENGINEERING

REVISION 11-10-20

TABLE OF CONTENTS

1. ELECTRICAL SERVICE INFORMATION.....	8
1.1 TEMPORARY CONSTRUCTION POWER:.....	8
1.2 PERMANENT POWER:	8
2. U.G. TEMPORARY POWER POST TYPE METER INSTALLATION	10
2.1 ADDITIONAL REQUIREMENTS:.....	10
3. O.H. TEMPORARY POWER POST TYPE METER INSTALLATION	11
4. UNDERGROUND DISTRIBUTION SPECIFICATIONS (3 PHASE) FOR NEW DEVELOPMENT	12
4.1 ADDITIONAL REQUIREMENTS:.....	12
5. JOINT TRENCH TYPICAL DETAIL	13
5.1 ADDITIONAL REQUIREMENTS:.....	13
5.2 REQUIRED TRENCH INSPECTION FOR PROJECTS:	13
5.3 REQUIRED TRENCH INSPECTION FOR SERVICES:.....	14
5.4 PLACING ELBOWS INTO EXISTING POWER EQUIPMENT:.....	14
5.5 FINAL PROJECT INSPECTION:	14
6. U.G. POWER INSTALLATION INTO EXISTING ENERGIZED EQUIPMENT	15
6.1 ADDITIONAL REQUIREMENTS:.....	16
7. SECONDARY PEDESTAL ACCESS-CLEARANCES.....	17
7.1 ADDITIONAL REQUIREMENTS:.....	17
7.2 NOTE FOR NEW SERVICES	17
8. TRANSFORMER AND PADMOUNTED EQUIPMENT	18
8.1 ADDITIONAL REQUIREMENTS:.....	18
8.2 NOTE FOR NEW SERVICES	18
9. SERVICES LARGER THAN 400 AMP 3 PHASE TRANSFORMER.....	19
9.1 ADDITIONAL REQUIREMENTS:.....	19
10. TYPICAL GROUNDING/BONDING FOR 100 AND 200 AMP SERVICES UP TO 480 VOLTS	20
10.1 ADDITIONAL REQUIREMENTS:.....	20
11. TYPICAL GROUNDING/BONDING FOR CT CABINET AND GUTTER	21
11.1 ADDITIONAL REQUIREMENTS:.....	21
12. ELECTRIC SERVICE REQUIREMENTS	22
12.1 CURRENT TRANSFORMER METERING-800 AMP MAXIMUM	22
12.2 THE CUSTOMER WILL PROVIDE AND INSTALL:	22
12.3 PROVO CITY POWER WILL OWN, PROVIDE AND INSTALL:	22
13. CT CABINET INSTALLATION	23
13.1 ADDITIONAL REQUIREMENTS:.....	23
14. METER SOCKET WIRING DIAGRAM 3-PHASE CLASS 320 AMP	24

14.1	ADDITIONAL REQUIREMENTS:.....	24
15.	METER SOCKET WIRING DIAGRAM 3-PHASE 200 AMP.....	25
15.1	ADDITIONAL REQUIREMENTS:.....	25
16.	CT METER SOCKET SPECIFICATION.....	26
16.1	ADDITIONAL REQUIREMENTS:.....	26
17.	ELECTRIC SERVICE REQUIREMENTS.....	27
17.1	SWITCHBOARD METERING.....	27
17.2	PROVO CITY POWER WILL OWN, PROVIDE AND INSTALL:.....	27
18.	UNDERGROUND SWITCHBOARD MAIN SERVICE(S) LARGER THAN 800 AMP MULTI-METERS UP TO 400 AMP PER METER.....	28
18.1	ADDITIONAL REQUIREMENTS:.....	28
19.	UNDERGROUND SWITCHBOARD SERVICE OVER 800 AMP.....	30
19.1	ADDITIONAL REQUIREMENTS:.....	30

TABLE OF FIGURES

Figure 2.1	Underground Temporary Power.....	10
Figure 3.1	Overhead Temporary Power.....	11
Figure 4.1	Underground Distribution.....	12
Figure 5.1	Trench Detail.....	13
Figure 6.1	Connecting to a Sectionalizer.....	15
Figure 6.1.2	Connecting to a Pedestal.....	15
Figure 6.1.3	Connecting to a Transformer.....	16
Figure 7.1	Secondary Pedestal (Typ. 12" x 20" lid approx.).....	17
Figure 8.1	Access Clearances.....	18
Figure 9.1	Pad Specifications.....	19
Figure 10.1	Typical Grounding and Bonding.....	20
Figure 11.1	Typical CT Grounding and Bonding.....	21
Figure 13.1	CT Cabinet Installation.....	23
Figure 14.1	Meter Socket Wiring Diagram (320 amp).....	24
Figure 15.1	Meter Socket Wiring Diagram (200 amp).....	25
Figure 16.1	CT Meter Socket Specification.....	26
Figure 18.1	Switchboard Service larger than 800 amp (Multi-meters).....	28
Figure 19.1	Switchboard Service arger than 800 amp.....	30

DEFINITIONS

ANSI — American National Standards Institute.

Arc flash hazard — A dangerous condition associated with the release of energy caused by an electric arc.

Bushings — Plastic or nylon rings that attach to the ends of conduit to protect the electrical cable from sharp edges.

Bypass — A method which allows for service continuity to the customer while the meter is removed for test or inspection.

Common meter — A non-residential meter for general energy use in apartment complexes, multi-use, or other multi-occupancy buildings. General energy use includes common area and exterior lighting, irrigation, laundry rooms, etc. Also called a house meter.

CT — Current transformer (see *Current transformer*).

Current transformer — A set of coils that reduce the primary current to the customer by a known ratio to an amount within the current capacity of the meter.

Current transformer meter — A meter that requires current transformers because its current capacity is not as large as the customer's current load.

Customer — The individual requesting electrical service from Provo City Power.

Direct-connect meter — A meter energized to line voltage that carries all the load current. Also called a self-contained meter. No current transformer or voltage interface is used.

Direct-connect socket — A meter socket connected to service wires, energized to line voltage and in series with the customer's load without external instrument transformers. A self-contained meter is used in a direct-connect socket.

Drip loop — The loop formed by the customer conductors that connects to the power company service drop. The conductors are formed in a downward "loop" so water will not enter the customer's service mast (weatherhead).

Dwelling unit — A single unit, providing complete and independent living facilities for one or more persons, including permanent provisions for living, sleeping, cooking, and sanitation.

Dwelling, single-family — A building that consists solely of one dwelling unit.

Dwelling, two-family — A building that consists solely of two dwelling units.

Dwelling, multi-family — A building that contains three or more dwelling units.

Electric vehicles — See *EV below*.

ESRA — Electric Service Requirements Agreement, a formal, written agreement between the Company and the customer that describes the details of each installation. A Power Company representative fills out the ESRA during the design process.

EUSERC (Electric Utility Service Equipment Requirements Committee) — An association of electric utilities and manufacturers that creates standard designs for the interface between the electric utility's service and the customer's facility.

EV — Electric vehicle. An automotive type vehicle for highway use such as passenger cars, buses, trucks, vans and neighborhood vehicles primarily propelled by an electric motor powered by electrical energy from rechargeable batteries or another source onboard the vehicle.

EVSE — Electric vehicle supply equipment.

Fault current — The available current under bolted short-circuit conditions.

Fiberglass conduit — Rigid conduit made of UV-resistant fiberglass, colored black with red stripes

Free-standing metering assembly — A metering assembly not attached to a building.

GMC — Galvanized metallic conduit.

Grounding — Grounding in accordance with latest issue of NEC (Article 250, *Grounding*). Code enforcement agencies may require the ground connection to be visible when inspection is made. For safety reasons, the top of the ground rod should be flush or below ground level in permanent applications.

House meter — A non-residential meter for general energy use in apartment complexes, multi-use, or other multi-occupancy buildings. General energy use includes common area and exterior lighting, irrigation, laundry rooms, etc. Also called a common meter.

HDPE conduit — A non-pressure-bearing conduit made from high density polyethylene plastic. The Power Company limits the use of HDPE conduit for cable plowing and conduit boring.

Hub — A conduit attachment in, or out of, a meter base can, into which electrical connections may be plugged.

IMC — Intermediate metallic conduit.

Living space — An area within a structure where the environment is controlled for cooking, cleaning, entertaining or sleeping. A garage is not considered living space.

Mandrel — A non-flexible wooden cylinder, with pulling eyes at each end, pulled through conduit to confirm the conduit's integrity by testing for obstructions and/or flattening.

Manual link bypass — A bypass facility requiring the physical act of placing links across the line and load bypass studs, for the purposes of removing the meter and preventing an outage while maintaining service continuity.

Manufactured home — A factory-assembled structure or structures, site specific and transportable in one or more sections, designed to be used as a dwelling with a permanent foundation.

Meter — A device that measures and records the summation of electrical quantity over a period of time.

Meter socket continuous rating — The rating, in amperes, that a meter socket will continuously carry for three hours or more under stated conditions without exceeding the allowable temperature rise. Typical continuous duty ratings of sockets include 80, 160 and 320 Amps (ANSI C12.7).

Meter socket maximum rating — The maximum rating of a meter socket in amperes; 125% of the continuous rating (EUSERC Section 300). Maximum ratings include 100, 200, and 400 Amps.

Meter base — The mounting device consisting of jaws, connectors, and enclosure for socket-type meters. A mounting device may be either single or trough. The meter base is also referred to as a meter socket.

Meter base ring — A metallic ring secured to the meter base that can be sealed by the power company.

Meter pedestal — (Also see *free-standing metering assembly*.) A commercially built pedestal that contains a meter base and customer disconnect switches.

Metered service conductor — A conductor carrying customer load that is recorded by the Power Company's billing meter.

Mobile home — A factory-assembled structure or structures transportable in one or more sections, built on a permanent chassis and designed to be used as a dwelling without a permanent foundation.

Modular home — A factory-assembled structure or structures transportable in one or more sections, built on a permanent chassis and designed to be used as a dwelling with a permanent foundation.

Mule tape — Flat low friction polyester tape with a minimum pulling strength of 1250lbs.

NEC — The most recent publication of the National Electrical Code adopted by the state.

NEMA — National Electrical Manufacturers' Association.

NEMA 3R — A rating for water-tight enclosures, for any electrical equipment, indoors or outdoors.

NESC — The most recent publication of the National Electrical Safety Code adopted by the state.

Net metering — A debit and credit metering process in an account in which the customer owns and operates a qualified generating device that interconnects with the Power Company's electrical facilities. Net metering tariffs are available upon request.

Network metering — Single-phase service obtained from two of the phase wires and the neutral of a 4-wire system.

NFGC — The most recent publication of the National Fuel Gas Code.

Non-residential service — Service to any customer who does not qualify for residential service.

OSHA — Occupational Safety and Health Administration.

Overhead service — See *service drop*.

Phase converter — Any machine, circuit or device used to create additional phases for operating polyphaser motors or multi-phase devices from a single-phase source.

Plumb — (In this book, this term refers to the meter base.) Having the sides and front of the meter base perfectly vertical from both the front and side views.

Point of delivery — See *service point*.

Post — A pressure or thermally treated wooden structure that supports an underground service meter base.

Primary service — Services with delivery voltages greater than 600 volts.

Primary voltage — Over 600 volts.

Power factor — The cosine of the angle, expressed as a percent, between voltage and current. Also, the ratio of the active power to the apparent power.

PVC conduit — A gray-colored plastic pipe approved for use in electrical installations. Commonly referred to as polyvinylchloride pipe.

Residential service — Service furnished to customers for domestic purposes in single-family or duplex dwellings, or as defined by tariff.

Relocation — A change in location of any of the following electrical system components: 1) the meter base/socket, 2) the service drop, 3) the service lateral, or 4) the service entrance conductors.

Rewire — Work performed on electrical wiring that requires any of the following: 1) re-installation of the meter base/socket, 2) replacement of the service drop, 3) replacement of the service lateral, or 4) replacement of the service entrance conductors.

RMC — Rigid metallic conduit.

SAE — Society of Automotive Engineers.

Safety socket — A device consisting of a manual link bypass facility and a circuit closing nut and bolt assembly which de-energize the meter socket while the meter is removed for test or inspection.

Secondary distribution underground — 600 volts or less, going from transformer to secondary pedestal and between secondary pedestals.

Secondary pedestal — Fiberglass enclosure for secondary connections.

Secondary service — Customer delivery of secondary voltage, from either a transformer or a secondary pedestal to meter. See *service lateral*.

Secondary voltage — 600 volts and under.

Self-contained meter — A watt-hour meter connected directly to the supply voltage that is in series with the customer's load without external instrument transformers.

Select backfill material — Material used to bed and cover direct-burial cables or conduits, consisting of screened native soil or sand free of sharp or foreign objects.

Service — The conductors and equipment for delivering energy from the electric supply system to the wiring system of the premises served.

Service conductors, underground system — See *service lateral, underground*.

Service drop — The overhead service conductors from the utility's pole, including the splices that connect to the customer's service entrance conductors.

Service drop attachment point — The location where the service drop conductors connect to the customer's residence, building or structure.

Service entrance conductors (customer-owned) — The conductors between the terminals of the service equipment connecting to the service point. In an overhead system, the customer installs and owns the wires (service entrance conductors) from the splices at the service head (weatherhead). In an underground system, the customer installs and owns the wires (service entrance conductors) from the meter.

Service equipment — Customer-owned equipment, usually consisting of circuit breakers (or switches) and fuses, and their accessories, connected to the load end of service conductors to the customer's structure, and intended to constitute the main control and cutoff of the supply.

Service lateral, underground — The entire length of service conductors between the street main, including any risers at a pole or other structure, or from transformers, and the first point of connection to the service entrance conductors in a terminal box or meter or other enclosure, inside or outside the building wall. Where there is no terminal box, meter, or other enclosure, the point of connection is considered to be the point of entrance of the service conductors into the building.

Service point — The point of connection between the facilities of the serving utility and the premises' wiring.

Service trench — A trench provided by the customer for a service lateral.

Socket — A mounting device consisting of jaws, connectors, and enclosure for socket-type meters.

Spoil — Native material removed from a hole or trench that is piled above grade, adjacent to the hole or trench.

Sweep — A PVC, fiberglass or steel bend that changes the direction of the conduit.

Switchboard — A large panel or assembly of panels which contains buses, current transformers, meters, switches, and protective devices.

Tariff — A set of policies (or rules) and rates written by the Power Company, approved by the Public Service and Public Utility Commissions of each state served. All sections of the tariff are subject to updates at any time. Individual state rules may affect the Power Company's tariff. Tariff policy provides the working rules by which the Power Company serves its customers.

Test block facility (TBF) — An assembly used to bypass a self-contained meter socket.

Test bypass facility (TBF) — See *test block facility* (above).

Test switch — A device used by the Power Company to isolate the meter from current and voltage sources.

Timber — A pressure or thermally treated wooden structure that supports an overhead service. Length depends upon the type of installation.

Underground cable — Electrical cable approved by a Nationally Recognized Testing Laboratory (NRTL) suitable for direct burial in the ground or in conduit.

Underground service — Electric service supplied to the customer from the power company utilizing underground conductors.

Unmetered service conductor — A conductor carrying customer load that is not measured by the Power Company's billing meter.

Unused facility — A facility that exists with no recorded customer or contractual obligation for a length of time (specified by the State).

1. ELECTRICAL SERVICE INFORMATION

1.1 Temporary Construction Power:

- 1.1.1 All temporary electrical service installations shall meet Provo City Power specifications, National Electrical Code, and National Electrical Safety Code latest revisions. Address to be posted at building site.
- 1.1.2 Provo City requires owner\builder to supply and install temporary power pole including meter base, disconnects and outlets. (see Figures 2.1 or 3.1)
- 1.1.3 Temporary power connects are generally \$300.00. Additional charges may be necessary depending on size and type of temporary power request.
- 1.1.4 Owner\builder shall have a Provo City building permit number prior to temporary power connections.
- 1.1.5 Temporary power inspections will be scheduled on a first come basis. All temporary power installations up to 200 amps, shall be inspected by Provo City Power prior to connection. Call (801)852-6999. Anything over 200 amps shall be inspected by Building Inspection. Call (801)852-6450 or (801)852-6452.

1.2 Permanent Power:

- 1.2.1 All permanent electrical service installations shall meet Provo City Power service specifications, National Electrical Code and National Electrical Safety Code latest revisions, no customer owned equipment between meter base and meter. Address to be posted at building site.
- 1.2.2 Contact Provo City Power at 251 West 800 North Provo, UT. For service specifications or call (801)852-6852.
- 1.2.3 Application for permanent electrical service must be completed by owner builder\contractor prior to connection of permanent electrical service.
- 1.2.4 Main service disconnect is required outside at the meter location for all electrical service installations. Provo City Power shall inspect trench and conduit installation prior to backfill. Call (801)852-6999 to schedule electrical service trench inspections.
- 1.2.5 Meter and service locations are to be determined by Provo City Power. (see attachment to job copy drawings). General rules for the service location are as follows: the meter and main disconnect shall be setback from the front corner of the structure a maximum of 12'. The meter and main disconnect shall be on the side of the structure closest to the distribution power source intended for that site.
- 1.2.6 All underground and overhead electrical services shall be inspected by Provo City Building Inspection prior to connection by Provo City Power. Call (801)852-6450 or (801)852-6452 to schedule permanent power inspection.
- 1.2.7 All new developments will be serviced underground; owner/developer will be responsible to provide and install all underground conduit, transformer pads/vaults, and secondary boxes, ground sleeves will be provided by Provo City Power and installed by contractor. The underground electrical distribution layout shall be completed or approved by Provo City Power engineering division.
- 1.2.8 All services over 200 amps require sch. 40 PVC conduit and conductor to be supplied, installed, terminated and maintained by owner / contractor per NEC, from the meter base to the power source supplied by Provo City. Services 200 amps and below Provo City will provide the conductor up to 75 feet max. The cost of these conductors is included in the

standard connection fees. For longer lengths consult with Provo City Power for additional cost.

- 1.2.9 Provo City Power will not allow any new structure to be constructed under/over any Provo City transmission/distribution, underground/overhead high voltage lines, or within any Right-of-Way and Public Utility Easement. All buildings and structures must meet Provo City Power overhead horizontal clearance requirements: 12' for single structures, 20' for multiple level structures from the nearest phase conductor this includes balconies and edge of roof line. Other options: the power lines could be buried at owners' expense. Please contact Provo City Power Engineering division when conflicts are identified, (801) 852-6852.

2. U.G. TEMPORARY POWER POST TYPE METER INSTALLATION

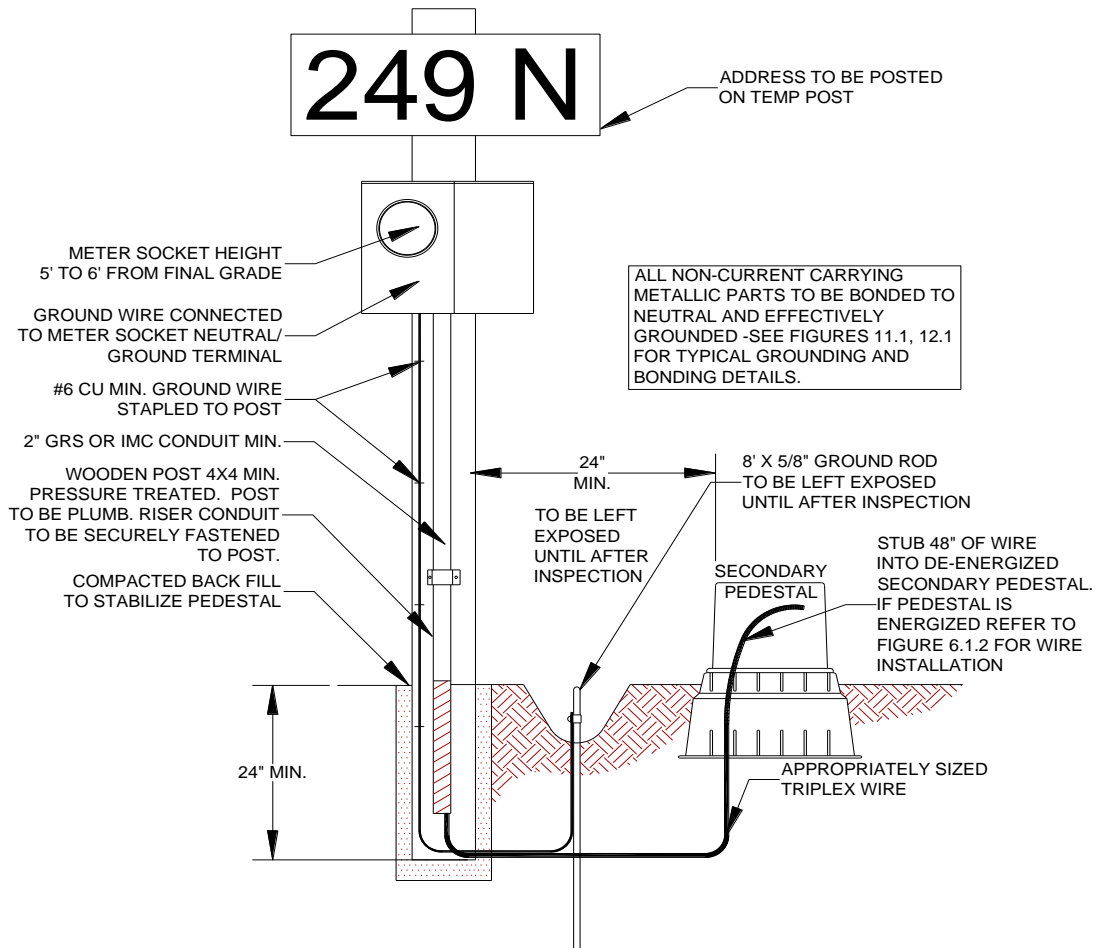

Figure 2.1 Underground Temporary Power

2.1 Additional Requirements:

- 2.1.1 Weatherproof, 3 wire, 240V, breaker and outlet cabinets are required. Ground fault circuit interrupters are required. (GFCI) on all outlets.
- 2.1.2 Pedestal and related equipment furnished by customer.
- 2.1.3 Installation by customer.
- 2.1.4 Pedestal must be placed within 10 feet and no closer than 2 feet to existing transformer or secondary pull box. Do not obstruct access to power boxes
- 2.1.5 Wire and trench to be furnished by customer.
- 2.1.6 Meter shall face street.
- 2.1.7 Meter pedestal up to 200 amps to be inspected by Provo City Power. Call (801)852-6999
- 2.1.8 Call (801)852-6999 for access to transformer enclosures or secondary pedestals.
- 2.1.9 Temporary power requirements larger than 200A will be approved and inspected by Provo City Building Inspection and installed by customer.

3. O.H. TEMPORARY POWER POST TYPE METER INSTALLATION

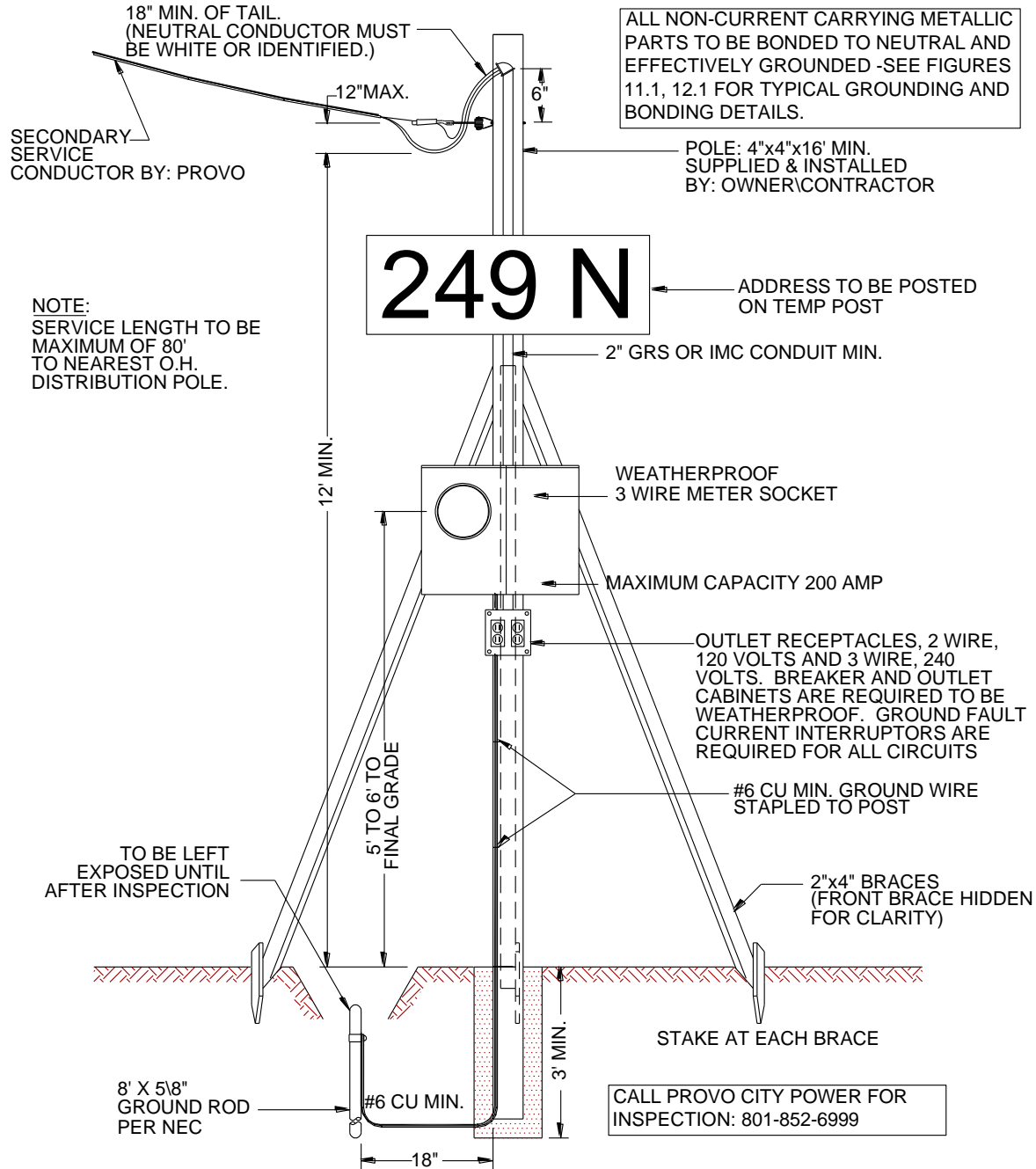

Figure 3.1 Overhead Temporary Power

4. UNDERGROUND DISTRIBUTION SPECIFICATIONS (3 PHASE) FOR NEW DEVELOPMENT

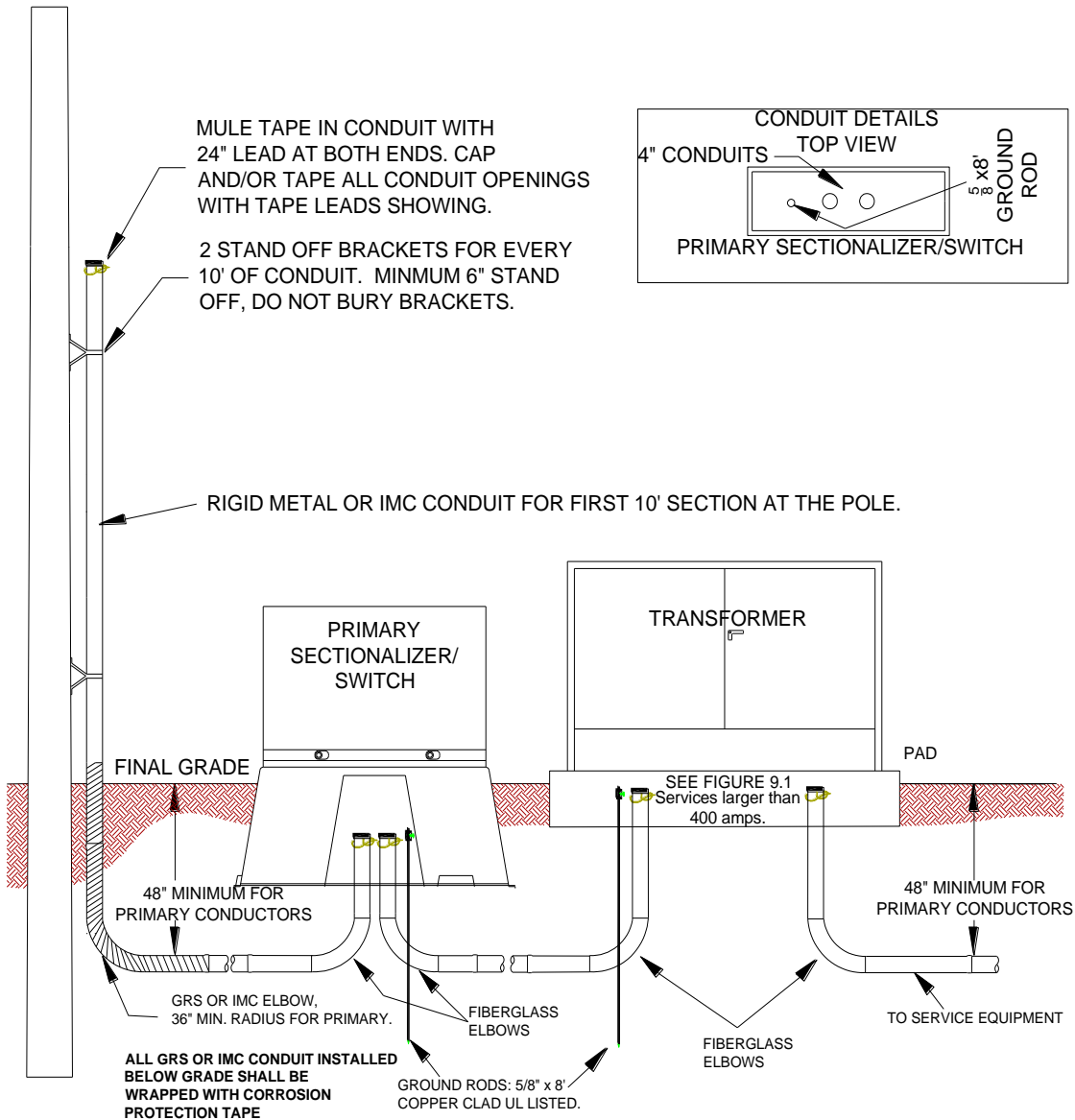

Figure 4.1 Underground Distribution

4.1 Additional Requirements:

- 4.1.1 Trenches and pad mount transformer locations must be compacted to 95% compaction.
- 4.1.2 All depths shown must be from finished grade. Red warning tape to be placed in trench (2' above conduit). Minimum depth for primary and secondary conduit is 48"; or 24" for services and streetlights. See trench detail drawing for specifications.
- 4.1.3 PVC sch. 40 4" or larger required for primary.
- 4.1.4 All trenches must be left open until final inspection by Provo City Power at (801)852-6999. Customer is responsible to secure all open trenches until final approval.

5. JOINT TRENCH TYPICAL DETAIL

COMMERCIAL / RESIDENTIAL SUBDIVISION

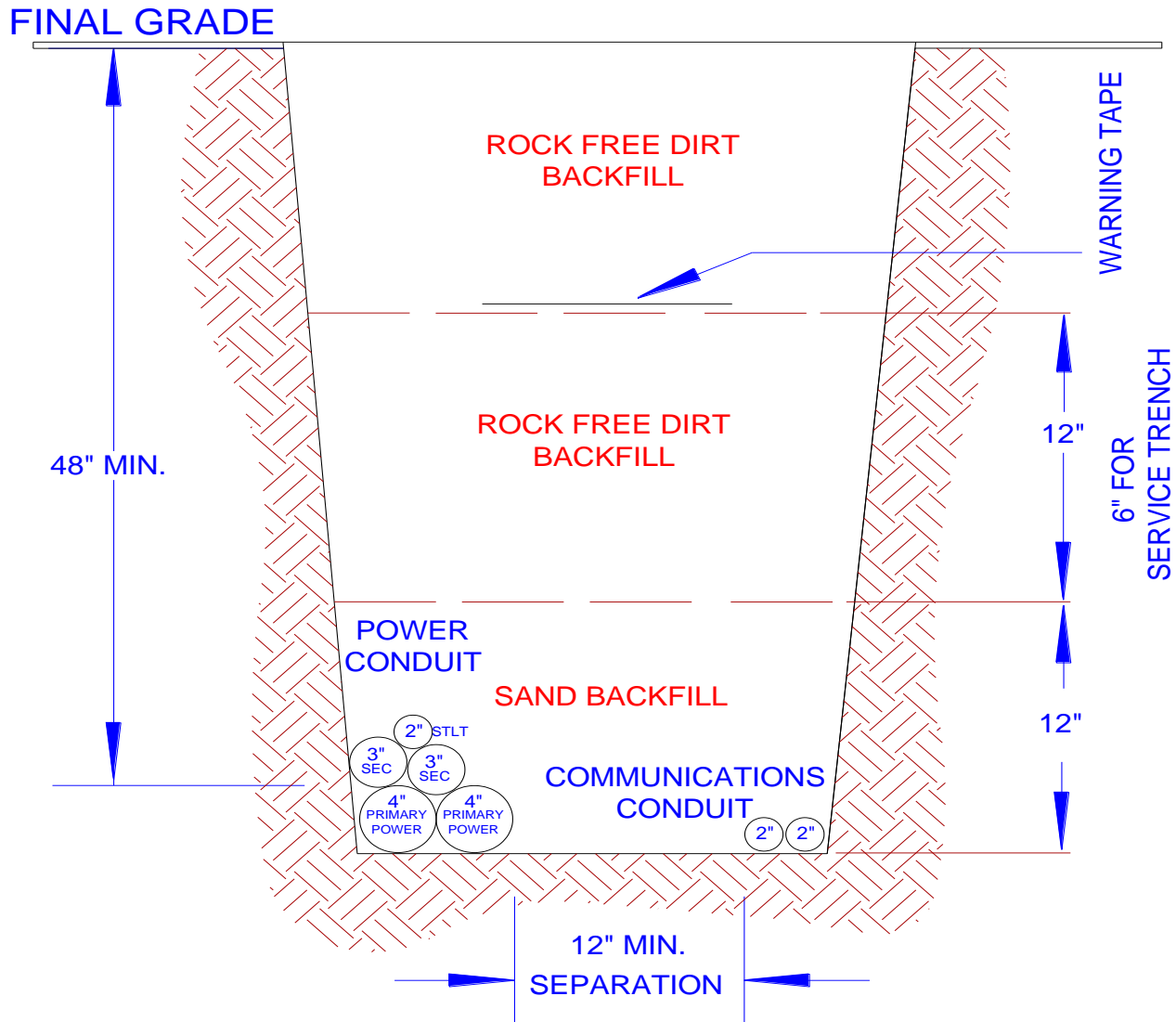

Figure 5.1 Trench Detail

5.1 Additional Requirements:

- 5.1.1 Provo City Power to approve backfill material
- 5.1.2 Provo City Power shall inspect trench/conduit prior to backfill.
- 5.1.3 Primary depth 48" minimum.
- 5.1.4 Secondary depth 48" minimum.
- 5.1.5 Service depth 24" minimum.

5.2 Required Trench Inspection for Projects:

- 5.2.1 For main line trench inspections: Call after conduit has been placed in trench and 12" of sand has been placed on conduit.

- 5.2.2 Trench must be left open for inspection or you will be asked to re-open trench for inspection and for inspector to GPS conduit location.
- 5.2.3 Call the project engineer you have been working with. Provo Power Engineering: (801)852-6852

5.3 Required Trench Inspection for Services:

- 5.3.1 Call for service trench inspection before doing any backfill on trench. Provo City Power Dispatch: (801)852-6999

5.4 Placing Elbows into Existing Power Equipment:

- 5.4.1 Call after trench has been extended to base of power equipment, and conduit has been installed and left 2' short of power equipment (see pages 15-16). Leave trench open 8'-10' from equipment, provide fiberglass elbows and contact Provo City Power for assistance on installation. Call Power Dispatch: (801)852-6999
- 5.4.2 NEVER place conduit into live equipment.

5.5 Final Project Inspection:

- 5.5.1 Call when boxes are installed at proper height and are level, ground rods have been installed, mule tape has been placed in conduit, and conduit is at proper height.
- 5.5.2 Curb and gutter must be in before setting boxes. Elevation needs to be set by a surveyor. If elevation is too low, boxes and conduit will need to be re-installed to meet proper height.
DO NOT cut fiberglass elbows.
- 5.5.3 Call the project engineer you have been working with. Provo Power Engineering: (801)852-6852.

6. U.G. POWER INSTALLATION INTO EXISTING ENERGIZED EQUIPMENT

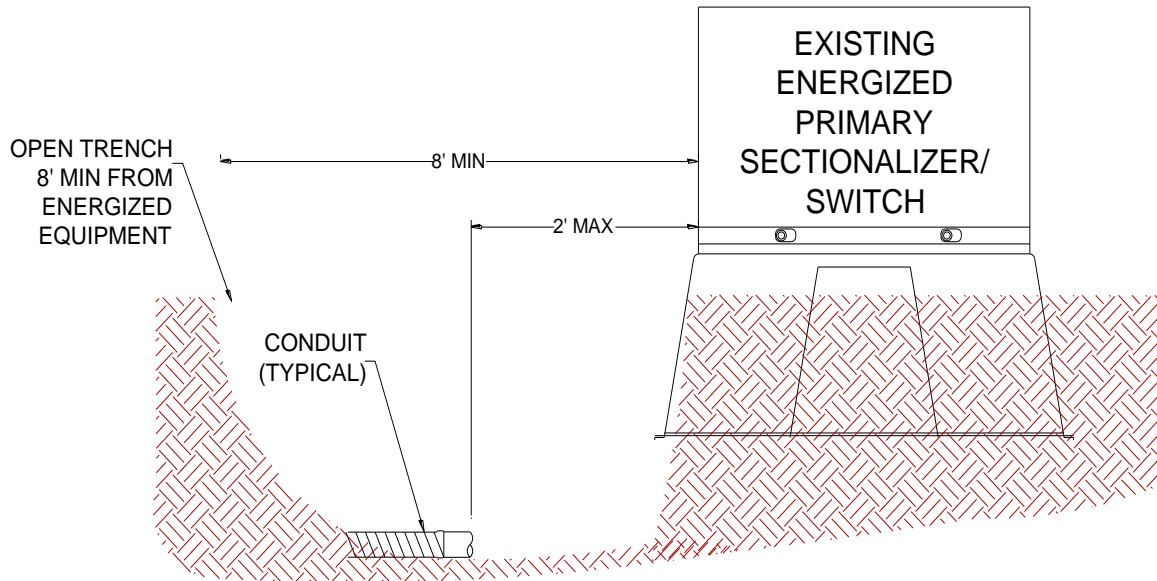

Figure 6.1 Connecting to a Sectionalizer

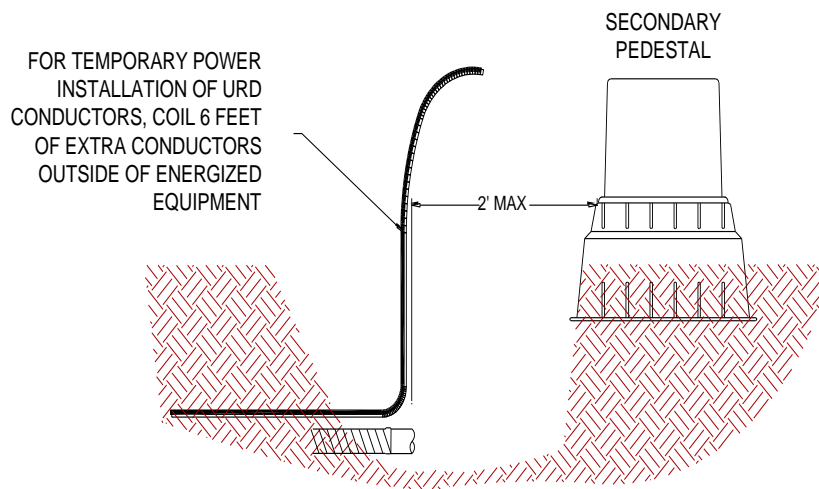

Figure 6.1.2 Connecting to a Pedestal

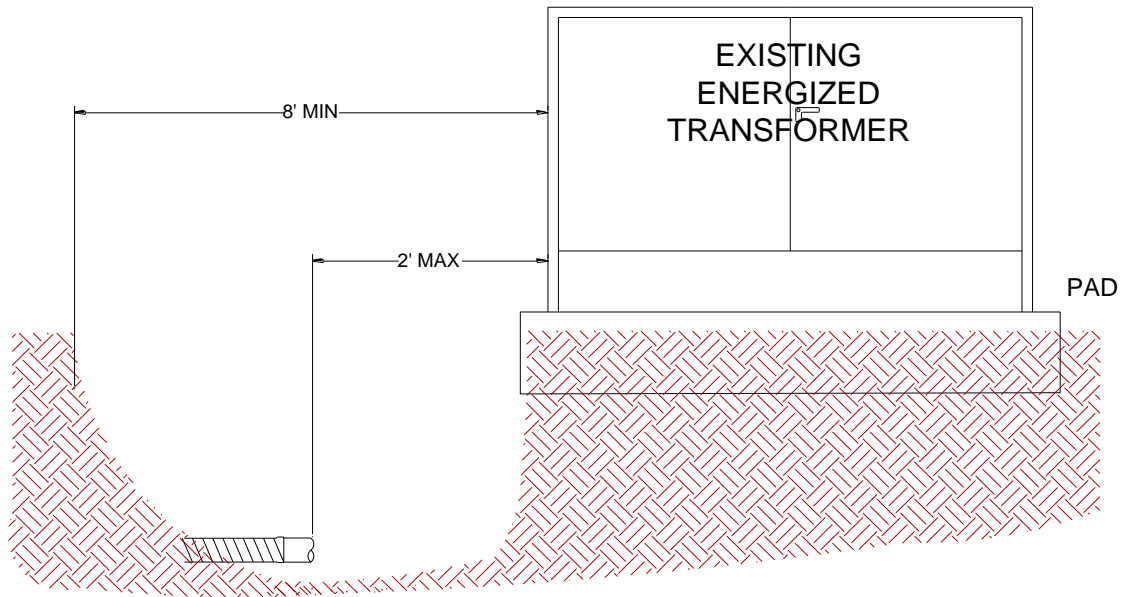

Figure 6.1.3 Connecting to a Transformer

6.1 Additional Requirements:

- 6.1.1 For safety reasons DO NOT install conduits/conductors inside energized equipment.
- 6.1.2 Stop installation of conduits at maximum of 2' from energized equipment.
- 6.1.3 Extend trench to the edge of the equipment. Leave trench open 8'-10' from equipment.
- 6.1.4 Contractor to supply sweep and additional conduit needed. Call Provo City Power (801)852-6999 for assistance to complete installation.

7. SECONDARY PEDESTAL ACCESS-CLEARANCES

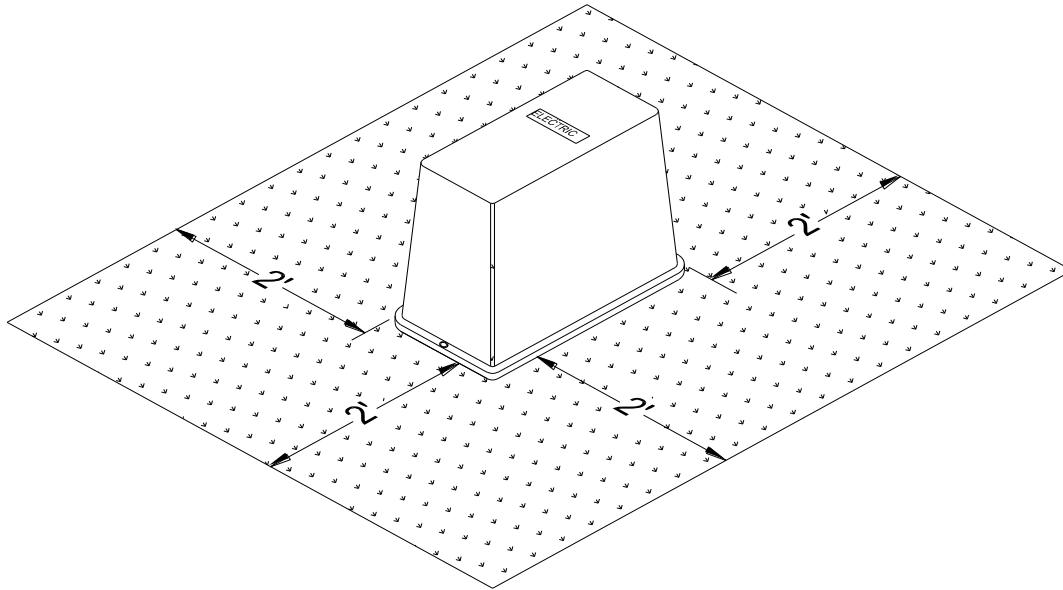

Figure 7.1 Secondary Pedestal (Typ. 12" x 20" lid approx.)

7.1 Additional Requirements:

- 7.1.1 In the event of an equipment failure or power outage, it is necessary for Provo City crews to have adequate access to secondary pedestal lids. Access to the front and sides and rear shall be 2'.
- 7.1.2 No trees, shrubs, fences, large landscape rocks, or other obstructions shall be permitted in access area.

7.2 Note for New Services

- 7.2.1 Transformers and secondary pedestals are locked for protection against electrical shock.
- 7.2.2 When installation of a new service requires access to a transformer or pedestal, owner\contractor should call Provo City Power at (801)852-6999.
- 7.2.3 All new conduit runs shall be installed by contractor into transformer\pedestal with Provo City Power supervision.
- 7.2.4 Blue stake laws prohibit any digging with equipment within the 2' safety zone. Please hand dig around any electrical equipment. For more details, please refer to www.bluestakes.org for complete details on excavation safety.

8. TRANSFORMER AND PADMOUNTED EQUIPMENT ACCESS-CLEARANCES

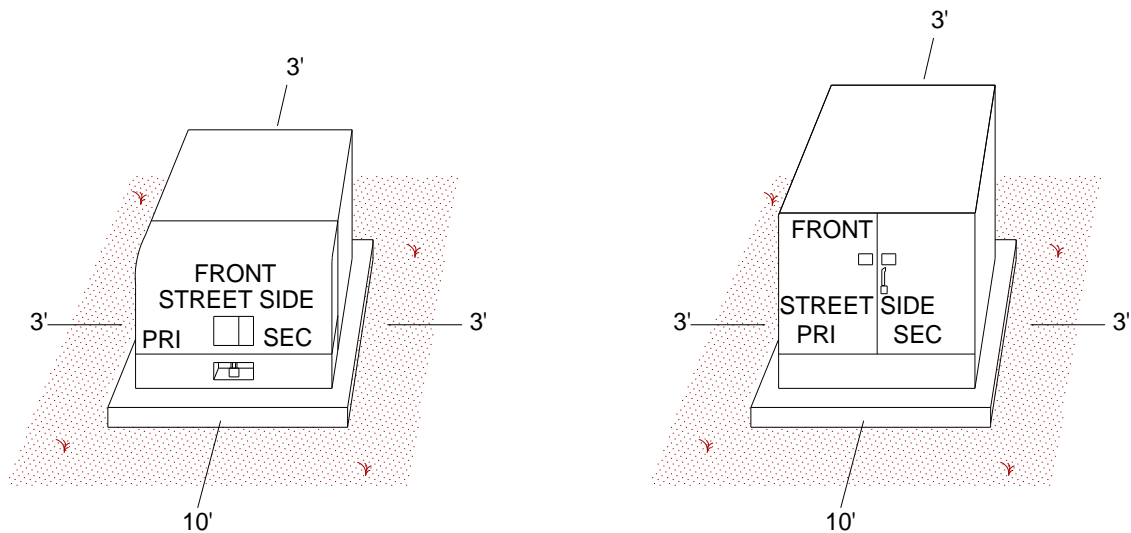

RESIDENTIAL SINGLE-PHASE TRANSFORMER
PADMOUNTED EQUIPMENT

COMMERCIAL 3-PHASE TRANSFORMER
PADMOUNTED EQUIPMENT

Figure 8.1 Access Clearances

8.1 Additional Requirements:

- 8.1.1 In the event of an equipment failure or power outage, it is necessary for utility crews to have adequate access to pad mounted equipment and transformers. Access to the front shall be ten feet, access to the rear and sides shall be three feet.
- 8.1.2 No trees, shrubs, fences, large landscape rocks, or other obstructions shall be permitted in access area.

8.2 Note for New Services

- 8.2.1 Pad mounted equipment, transformers and secondary pedestals are locked for protection against electrical shock.
- 8.2.2 When installation of a new service requires access to a transformer or pedestal, owner\contractor should call Provo City Power at (801)852-6999.
- 8.2.3 All new conduit runs shall be installed by contractor into transformer\pedestal with Provo City Power supervision.
- 8.2.4 Blue stake laws prohibit any digging with equipment within the 2' safety zone. Please hand dig around any electrical equipment. For more details, please refer to www.bluestakes.org for complete details on excavation safety.

9. SERVICES LARGER THAN 400 AMP 3 PHASE TRANSFORMER

PAD SPECIFICATION

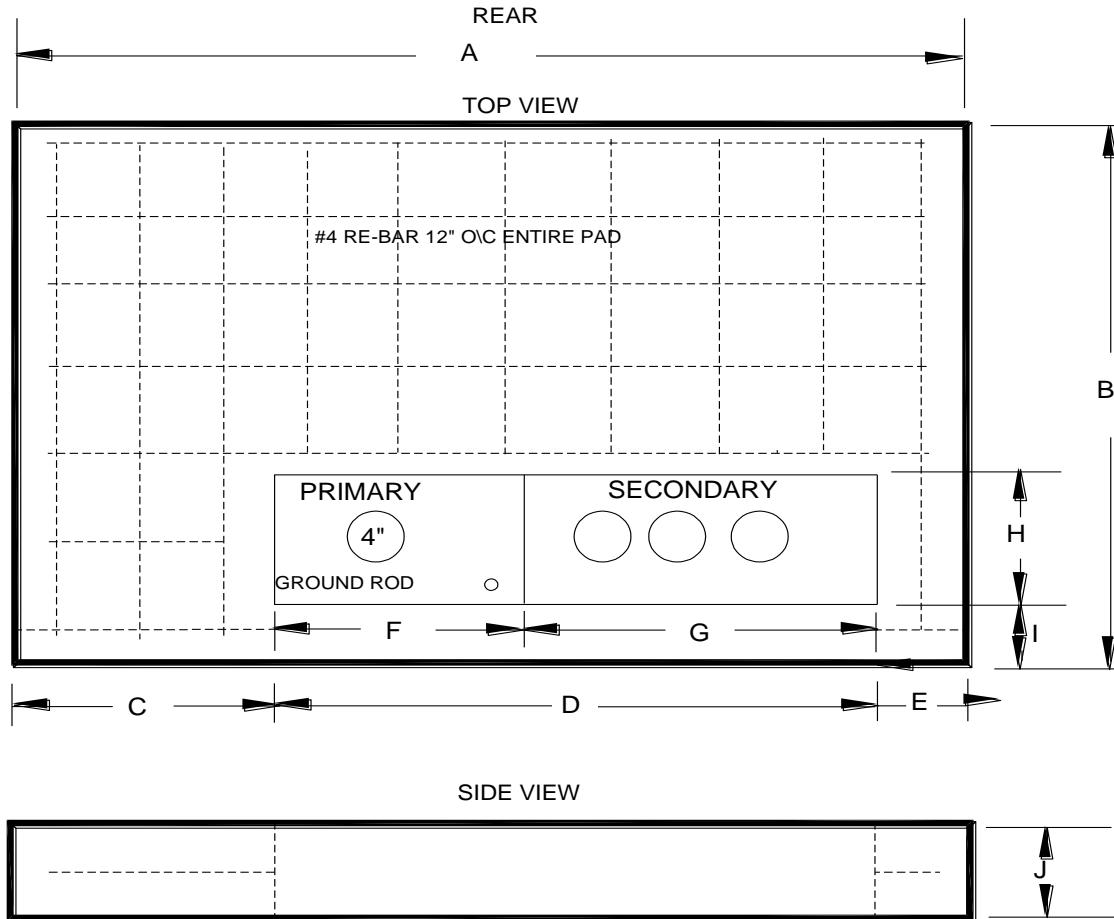

KVA	DIMENSIONS									
	A	B	C	D	E	F	G	H	I	J
75-112.5	70"	70"	23"	32"	15"	16"	16"	17"	15"	6"
150-500	86"	86"	29"	42"	15"	21"	21"	17"	15"	6"
750-3000	102"	102"	31"	50"	21"	25"	25"	17"	15"	6"

Figure 9.1 Pad Specifications

9.1 Additional Requirements:

- 9.1.1 Install #4 re-bar 12" o/c entire pad.
- 9.1.2 Install 5/8 x 8' copper clad ground rod within primary compartment.
- 9.1.3 Provo City Power to inspect pad prior to pour. Call (801)852-6852
- 9.1.4 3' min. clearance for both sides and rear of pad.
- 9.1.5 10' min. clearance in front of pad.

10. TYPICAL GROUNDING/BONDING FOR 100 AND 200 AMP SERVICES UP TO 480 VOLTS

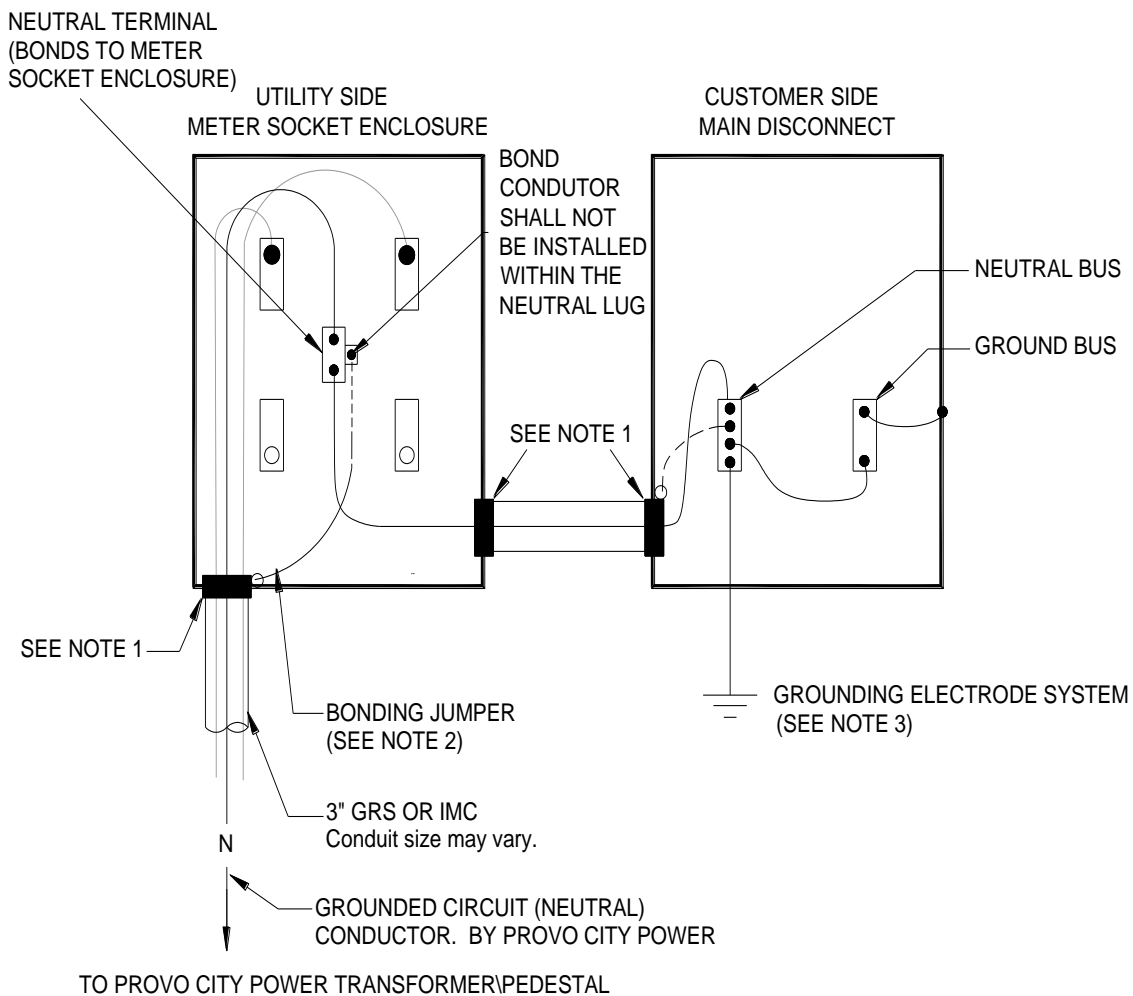

Figure 10.1 Typical Grounding and Bonding

10.1 Additional Requirements:

- 10.1.1 The metal conduit raceway shall be bonded to the neutral conductor using a grounding bushing (with bonding jumper), bonding locknuts, threaded conduit hub, or other as approved by Provo City Building Inspection.
- 10.1.2 When a grounding bushing is used, a bonding jumper shall be installed to connect with the neutral grounding terminal as required by Provo City Inspection Department. See NEC table 250-66 for bonding jumper sizes.
- 10.1.3 The grounding electrode system (consisting of metal water pipes, metal building frame, concrete encased electrode, ground ring, driven ground rods, etc.) shall be bonded to the neutral conductor and installed as required by Provo City Inspection Department. Call (801)852-6450. Concrete encased electrode shall be required for all new construction.

11. TYPICAL GROUNDING/BONDING FOR CT CABINET AND GUTTER

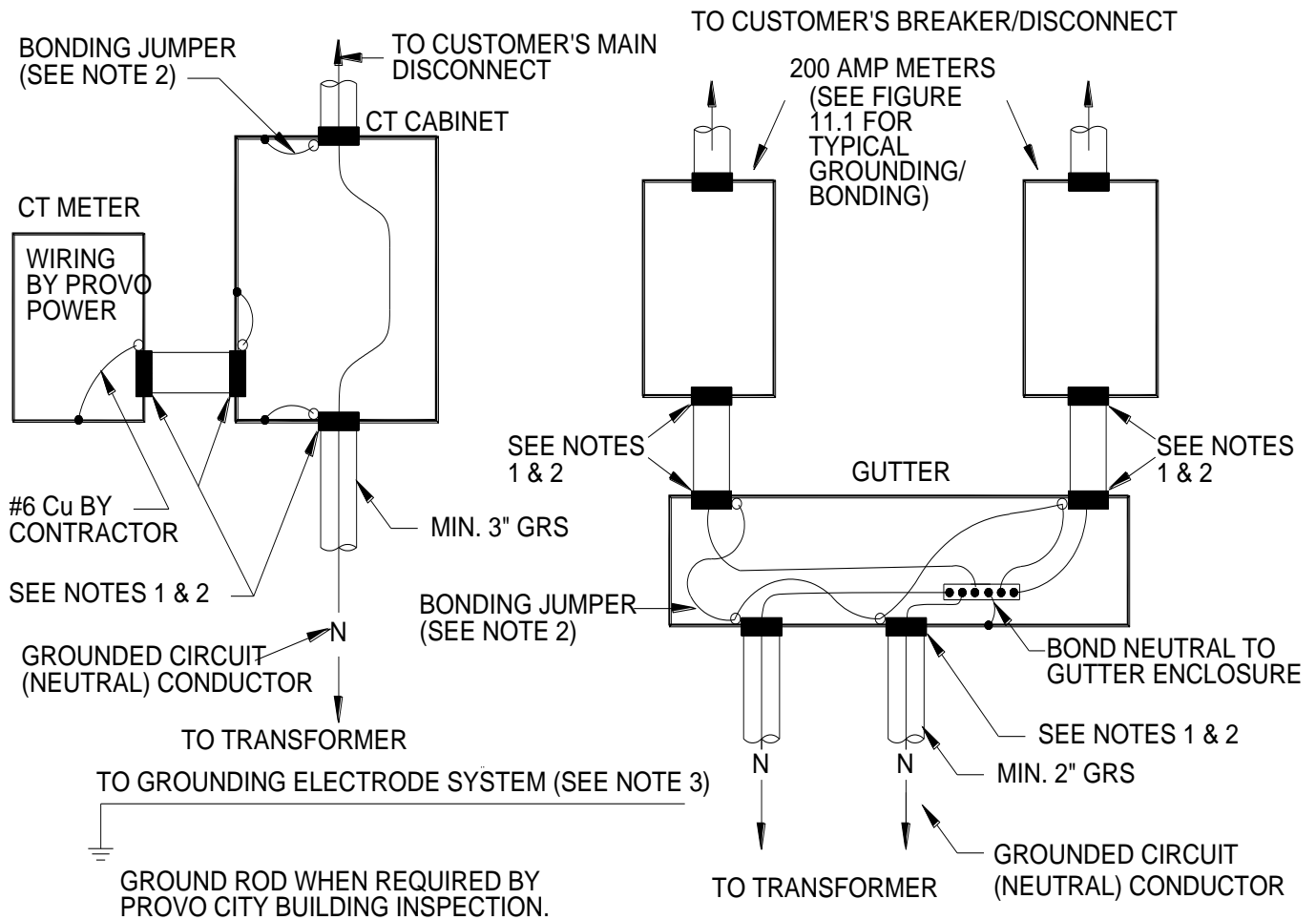

Figure 11.1 Typical CT Grounding and Bonding

11.1 Additional Requirements:

- 11.1.1 The metal conduit raceway shall be bonded to the neutral conductor by the use of a grounding bushing (with bonding jumper), bonding locknuts, threaded conduit hub, or other as approved by Provo City Building Inspection.
- 11.1.2 When a grounding bushing is used, a bonding jumper shall be installed to connect with the neutral grounding terminal as required by Provo City Building Inspection. The bonding jumpers shall be sized to meet NEC table 250-66 as required by Provo City Building Inspection.
- 11.1.3 The grounding electrode system (consisting of metal water pipes, metal building frame, concrete encased electrode, ground ring, driven ground rods, etc.) Shall be bonded to the neutral conductor and installed as required by Provo City Building Inspection. Concrete encased electrode shall be required for all new construction.

12. ELECTRIC SERVICE REQUIREMENTS

12.1 Current Transformer Metering-800 amp Maximum

- 12.1.1 Current transformer (C.T.) metering is required when a three-phase service exceeds 400 amperes, or when a single-phase service exceeds 320 continuous amperes. For services over 800 amperes see section on switchboard metering.
- 12.1.2 Main service disconnect is required to be outside at meter location. The C.T. metering equipment shall be mounted in a location approved by Provo City. Instrument transformers shall not be installed inside of the pad mounted transformer.
- 12.1.3 When metering equipment is installed at a location where it might be struck by a vehicle, the customer is required to install and maintain an approved barrier post.

12.2 The Customer Will Provide and Install:

- 12.2.1 The weather tight metallic cabinet (NEMA 3R, EUSERC 316 or equal, 24" x 48" x 11" for single phase and 36" x 48" x 11" for three phase minimum) sealable with a hinged door, securely mounted on a rigid surface. The top of the cabinet should be no more than 6 feet from final grade.
- 12.2.2 EUSERC approved (EUSERC 328A for single phase, 329A for three phase) current transformer mounting base rated 50,000 ampere fault duty.
- 12.2.3 The current transformer meter socket with a space reserved below the socket for a test switch. (EUSERC 339). The meter socket should be mounted so that the center of the meter is more than 5'6" from the final grade. Meter sockets with circuit closures or bypass clips will not be approved.
- 12.2.4 The conduit between the meter socket and the C.T. cabinet. Rigid 1" minimum with proper fittings and bushings, not to exceed 12" in length.
- 12.2.5 Terminate with approved connectors the conductors between the transformer and the line side of the current transformer-mounting base.
- 12.2.6 Terminate with approved connectors the conductors between the customer panel and the load side of the current transformer-mounting base.
- 12.2.7 Barrier post (6" diameter, concrete filled) where metering equipment is installed in vehicle traffic area.
- 12.2.8 Grounding per NEC (article 250 grounding) for all meter and current transformer enclosures.
- 12.2.9 Placards for identifying the location of additional breakers.
- 12.2.10 Color-coded conductors for single phase services over 200 amps and three phase services. For 120/208V services, please use black, red, and blue for phase conductors and white for neutral conductor. For 277/480V services, please use brown, orange, and yellow for phase conductors and grey for neutral conductor.

12.3 Provo City Power Will Own, Provide and Install:

- 12.3.1 The meter and test switch.
- 12.3.2 The current transformers and current transformer bus bars.
- 12.3.3 The wiring between the current transformer and the meter socket enclosure.
- 12.3.4 Any changes or deviations must have prior written approval by Provo City Power Metering division. (801)852-6855.

13. CT CABINET INSTALLATION

(SERVICES 400-800 AMP CT'S LOCATED IN CT CABINET)

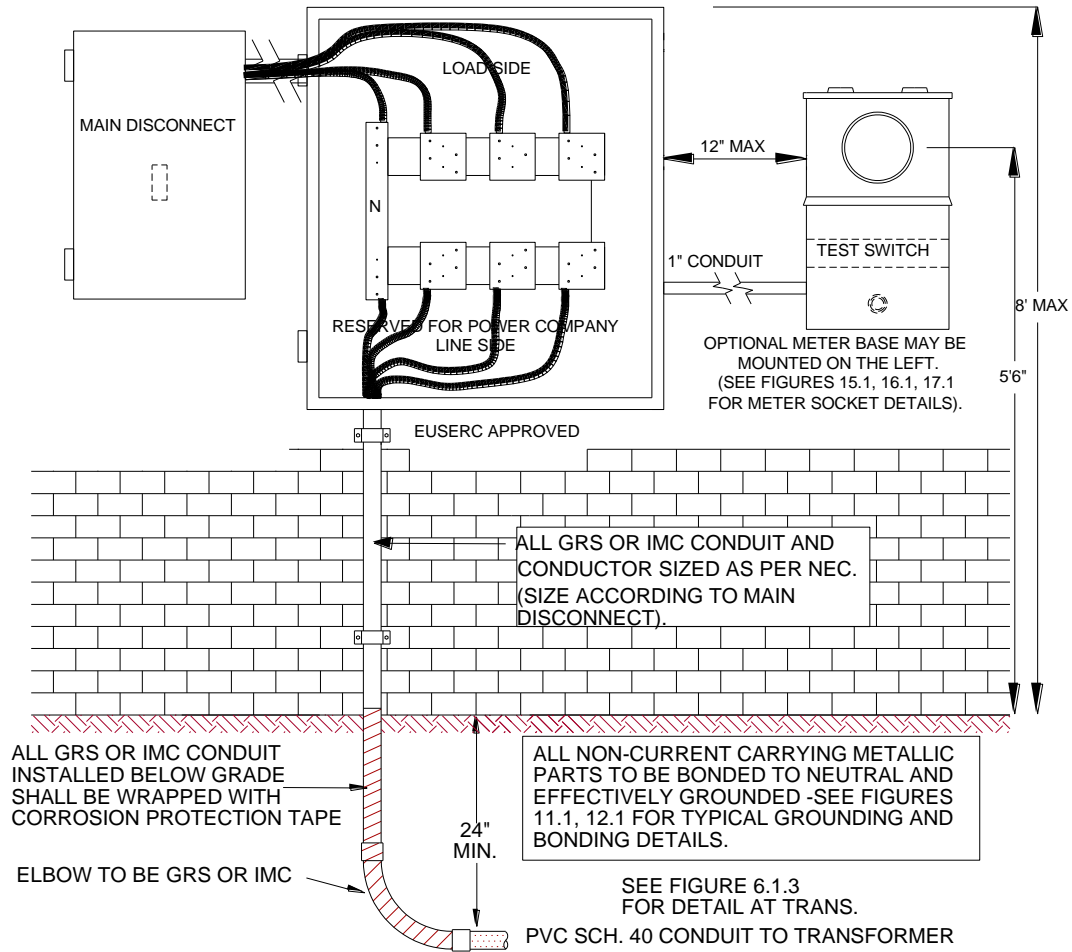

Figure 13.1 CT Cabinet Installation

13.1 Additional Requirements:

- 13.1.1 CT cabinet and meter base to be sealable by Provo City Power.
- 13.1.2 Main service disconnect is required outside at the meter location
- 13.1.3 Installation location shall be approved by Provo City Power.
- 13.1.4 Conduit clamp must be above ground.
- 13.1.5 For services up to 200 amps Provo City Power to terminate secondary conductors.
- 13.1.6 Call (801)852-6999 for service inspection prior to back fill of trench.
- 13.1.7 Call (801)852-6450 for permanent power inspection.
- 13.1.8 For services greater than 200 amps, conduit/conductors to be supplied, installed, terminated and maintained by owner/contractor, per NEC, from the meter base or CT enclosure to the power source supplied by Provo City Power.
- 13.1.9 For 4 wire delta services, identify right hand CT mounting base as the high (power) leg and identify with orange markings on right side of CT mounting base as required by NEC.

14. METER SOCKET WIRING DIAGRAM 3-PHASE CLASS 320 AMP

THREE PHASE, 4 WIRE WYE DELTA 120/208, 277/480 VOLT (CLASS 320 AMP, 7 TERMINAL SOCKET WITH LINK BYPASS, LEVER BYPASS and PRESSURE RELEASE)

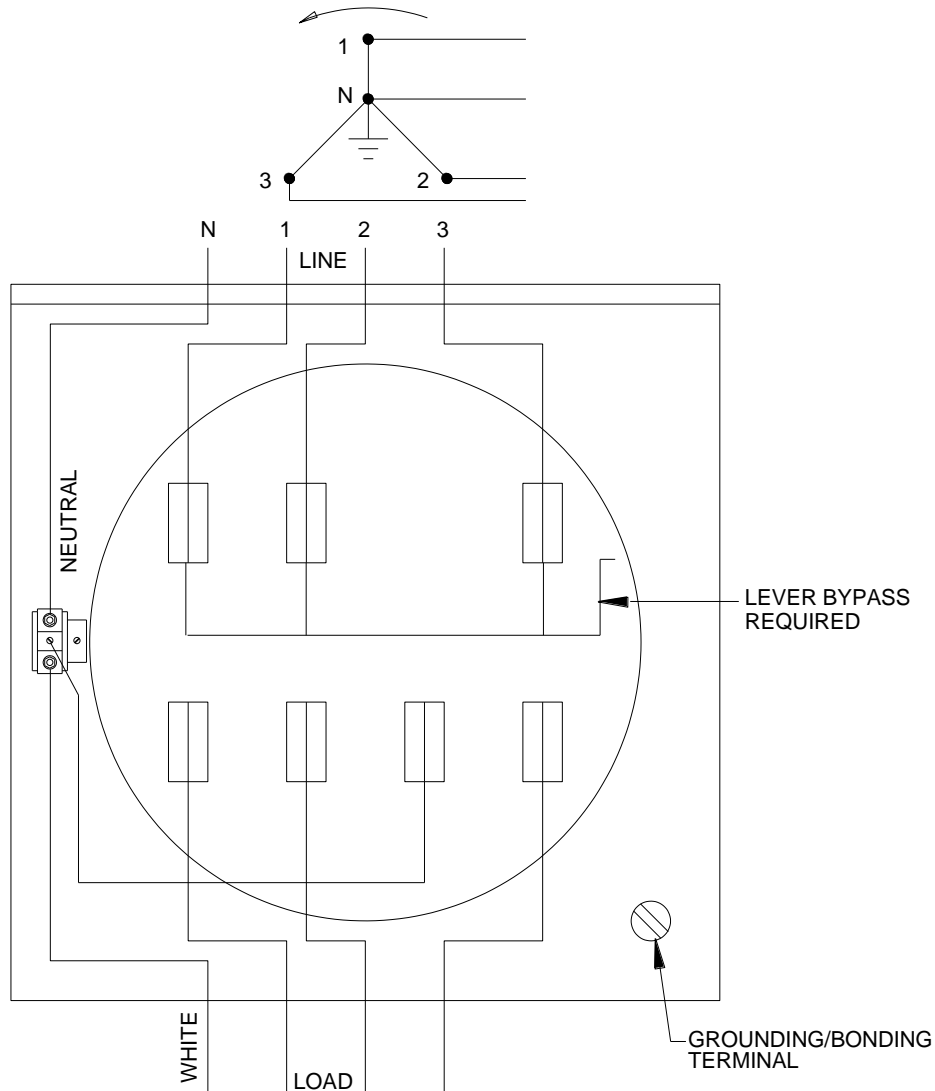

Figure 14.1 Meter Socket Wiring Diagram (320 amp)

14.1 Additional Requirements:

- 14.1.1 Wire size range: lugs suitable for 1\0 - 500 kcmil cu/al conductors.
- 14.1.2 Approximate dimensions : 7"(d) x 16"(w) x 27"(h).
- 14.1.3 Meter socket shall have bypass. (link or manual)
- 14.1.4 Conduit and conductor to be supplied, installed and terminated by owner/contractor per NEC, from the meter base to the transformer or secondary box supplied by Provo City Power. For services 200 amps and below Provo City Power will provide the conductor.

15. METER SOCKET WIRING DIAGRAM 3-PHASE 200 AMP

THREE PHASE, 4 WIRE WYE DELTA 120/208, 277/480 VOLT (200 AMP, 7 TERMINAL SOCKET WITH LINK BYPASS, LEVER BYPASS and PRESSURE RELEASE)

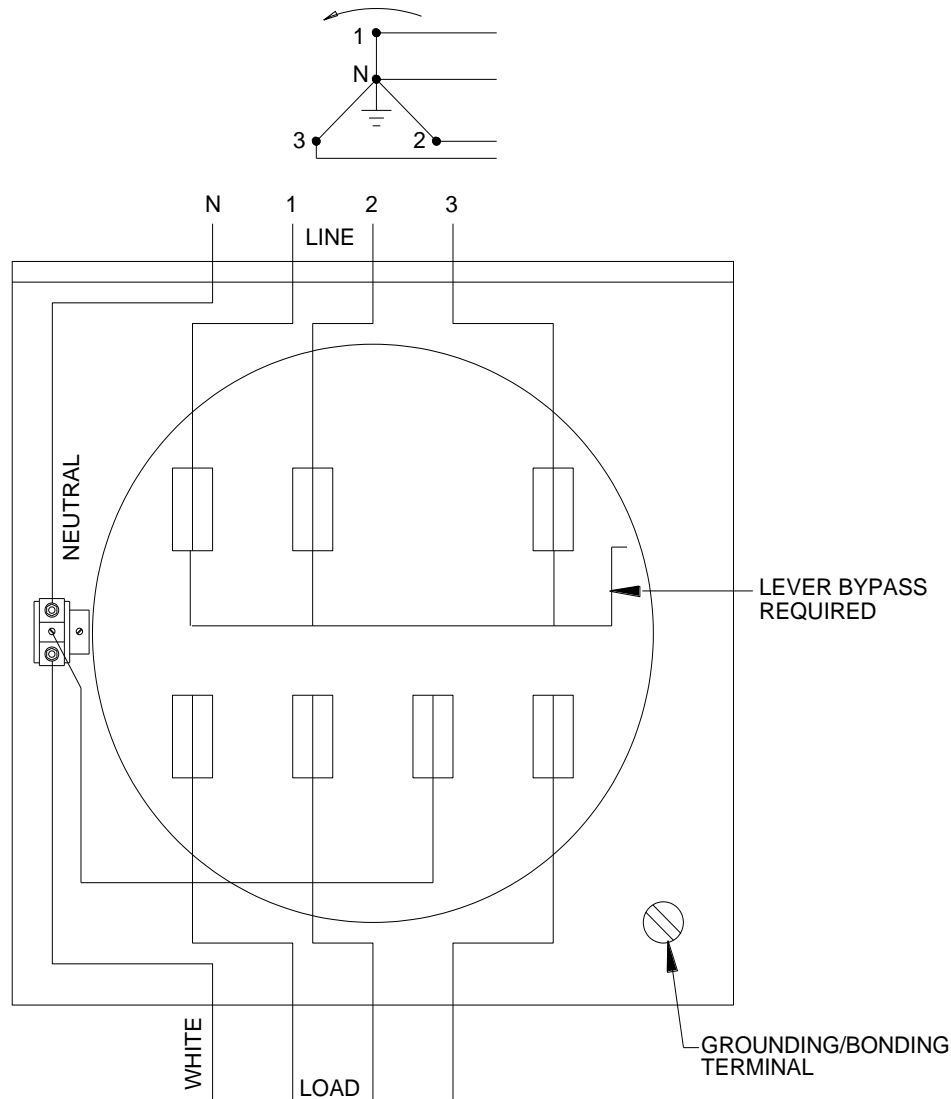

Figure 15.1 Meter Socket Wiring (200 amp)

15.1 Additional Requirements:

- 15.1.1 Wire size range: lugs suitable for #2 - 350 KCMIL cu/al conductors.
- 15.1.2 Approximate dimensions : 5"(d) x 13"(w) x 19"(h).
- 15.1.3 Meter socket shall have bypass. (link or manual)
- 15.1.4 Knockouts: three on bottom and one each on both sides and back; knockouts are concentric type with a maximum diameter of 3".
- 15.1.5 For overhead services, meter sockets are furnished with a hub sized as needed; available hub sizes are 1- $\frac{1}{4}$ ", 1- $\frac{1}{2}$ ", 2" and 2- $\frac{1}{2}$ ".

16. CT METER SOCKET SPECIFICATION

THREE PHASE, 4 WIRE WYE OR DELTA 120/208, 277/480 VOLT (200+ AMP SERVICES, CT METERED)

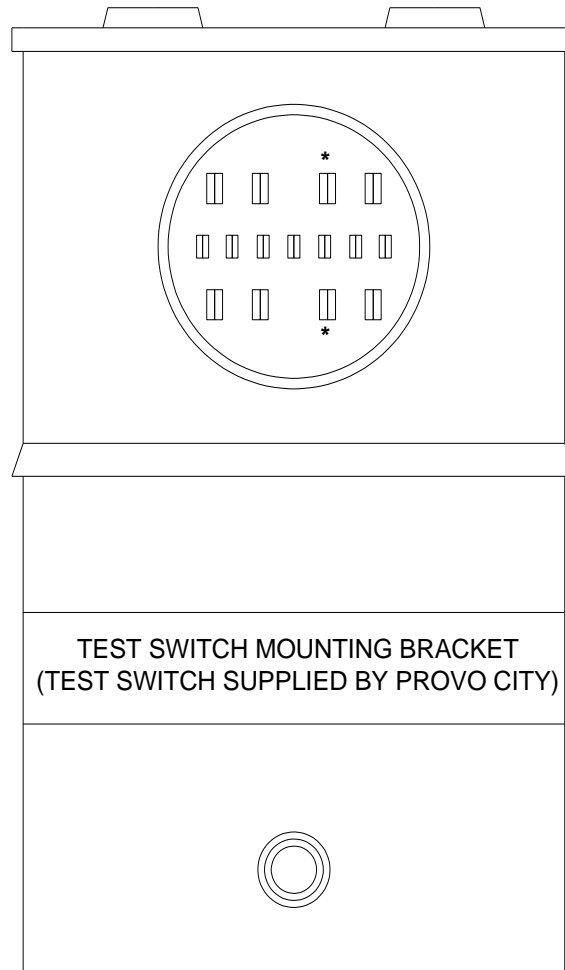

Figure 16.1 Meter Socket Specification

16.1 Additional Requirements:

- 16.1.1 (*) No terminals in these 2 positions on 13 terminal sockets. 13 socket recommended. 15 socket is acceptable (form 8s and 9s meters).
- 16.1.2 Approximate dimensions : 4.5"(d) x 12"(w) x 20"(h).
- 16.1.3 Meter socket shall be sealable by Provo City Power.
- 16.1.4 Meter socket shall have test switch compartment to mount 9.5" test switch. Test switch supplied and installed by Provo City Power. Provo City Power to wire meter socket, CT's and test switch.

17. ELECTRIC SERVICE REQUIREMENTS

17.1 Switchboard Metering

- 17.1.1 A EUSERC (EUSERC 354 outdoor) switchboard metering section is required when the service entrance rating is greater than 800 amperes. The metering current transformers will be located in the current transformer compartment. The meter and test switch will be mounted on the hinged cover of the compartment. The area below this compartment's barrier may be used as a main switch (breaker) compartment, or a load distribution compartment. The metering compartment shall be on the supply side of the main switch or breaker.
- 17.1.2 The mounting pad for all switchboard metering enclosures will be a minimum 4" thick concrete pad, extending 3' in front of the enclosure to ensure an adequate and safe work area.
- 17.1.3 The customer will provide and install:
- 17.1.4 The conduit and conductors, a maximum of 48 conductors (12 per phase) not to exceed 750 MCM maximum, conductor sized per NEC.
- 17.1.5 The switchboard service section, current transformer mounting base, panels, pulling section separate from the CT compartment, meter socket and provisions for a test switch.
- 17.1.6 Current transformer buss bars and terminating bolts must be secured in place and shall be provided with nuts, flat washer, spring washers, and all parts must be plated to prevent corrosion. Buss bars are required from the pull section into the service section.
- 17.1.7 All pull and termination sections shall be full front access. Cover panels shall be removable, sealable, and provided with two lifting handles, and limited to 9 square feet in area.
- 17.1.8 All removable panels and covers to the compartments used for terminating or routing conductors shall have sealing provisions.
- 17.1.9 Grounding must meet NEC requirements. Lugs for terminating the customer's ground wire shall be located outside of the sealable section and shall be designed to readily permit the customer's neutral system to be isolated, when necessary, from Provo City's neutral.
- 17.1.10 The NEC requires a clear workspace of 78"(h) x 70"(w) x 48"(d) in front of metering equipment.

17.2 Provo City Power Will Own, Provide and Install:

- 17.2.1 The meter and test switch.
- 17.2.2 The current transformers.
- 17.2.3 The wiring between the current transformers and the meter test switch.
- 17.2.4 Any changes or deviations must have prior written approval by Provo City Power metering division. (801)852-6855.

18. UNDERGROUND SWITCHBOARD MAIN SERVICE(S) LARGER THAN 800 AMP MULTI-METERS UP TO 400 AMP PER METER

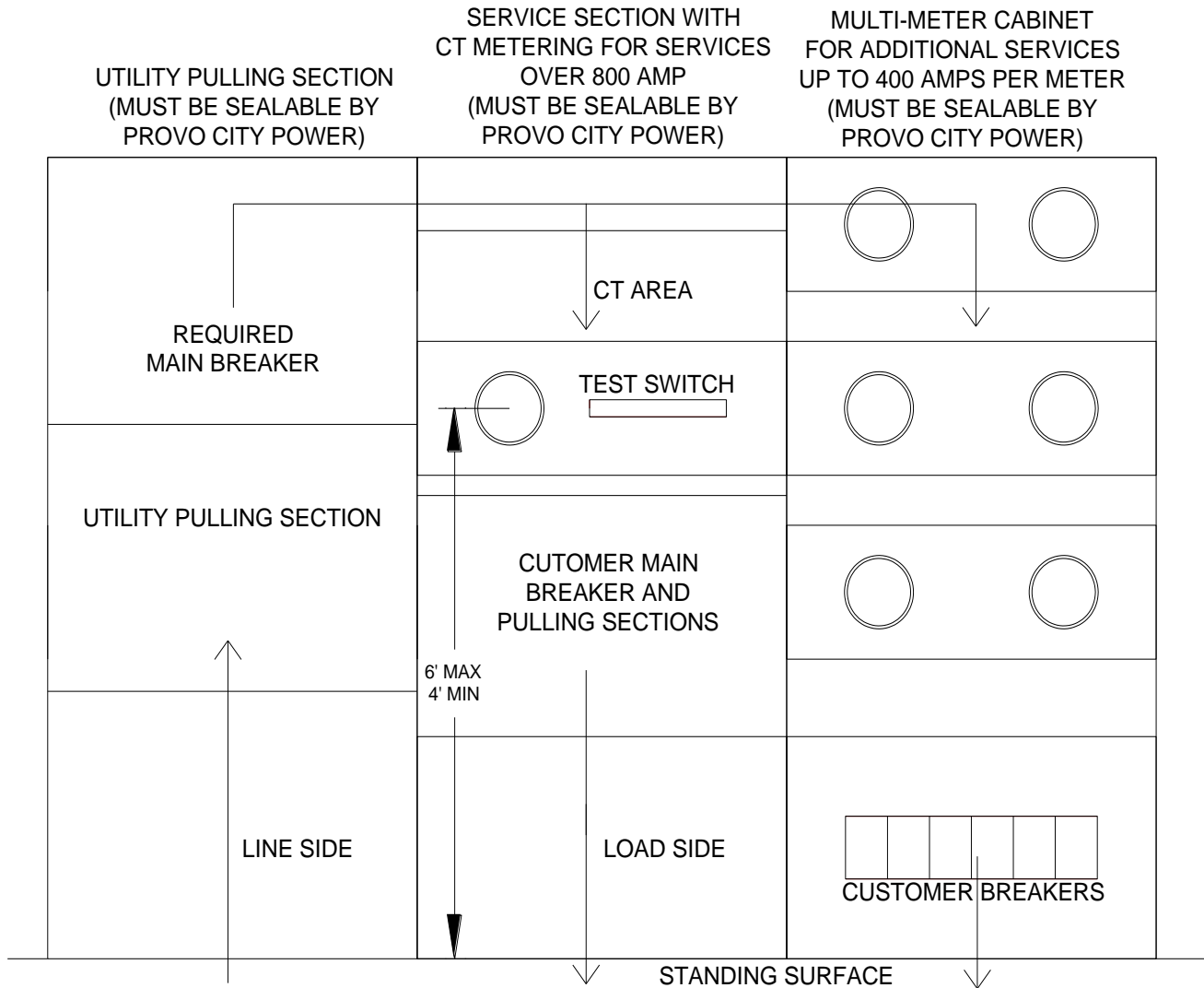

Figure 18.1 Switchboard Service larger than 800 amp (Multi-meter)

18.1 Additional Requirements:

- 18.1.1 Minimum pulling section dimensions: 800-1200 amp 30" wide; 1200-2000 amp 35" wide.
- 18.1.2 For switchboard ratings below 400 amp and above 2000 amp consult Provo City Power Engineering.
- 18.1.3 Bus bars, with provisions for termination lugs as EUSERC 347 are required from the pull section into the service section.
- 18.1.4 Customer shall provide a drawing with dimensions of proposed service equipment.

- 18.1.5 Exterior doors on switchboards must be sealable and hold securely at 90°.
- 18.1.6 Meter panels shall not be hinged on a filler panel. Hinged meter panel must be capable of being opened 90° with meter in place.
- 18.1.7 A barrier is required inside the service section between the CT compartment and the customer pulling section.
- 18.1.8 Main service disconnect is required outside at the meter location. Meter location shall be approved by Provo City Power.
- 18.1.9 Service disconnects rated 1000A or more and with a voltage line to ground greater than 150V shall be provided with ground fault protection of equipment (GFPE)
- 18.1.10 Conduit and conductor to be supplied, installed, terminated and maintained by owner /contractor per NEC, from the switchboard to the power source supplied by Provo City Power.

19. UNDERGROUND SWITCHBOARD SERVICE LARGER THAN 800 AMP

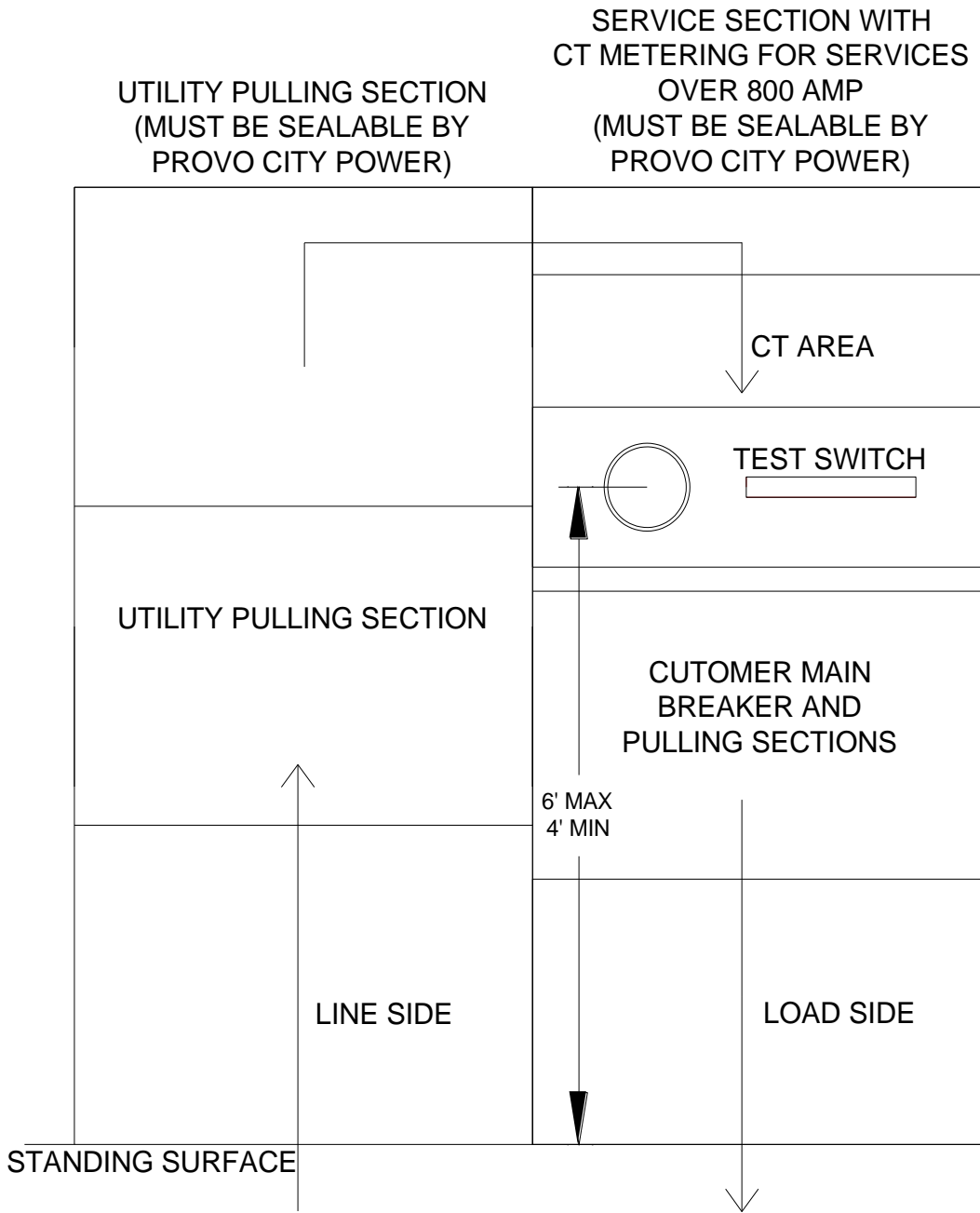

Figure 19.1 Switchboard Service larger than 800 amp

19.1 Additional Requirements:

- 19.1.1 Minimum pulling section dimensions: 800-1200 amp 30" wide; 1200-2000 amp 35" wide.
- 19.1.2 For switchboard ratings below 400 amp and above 2000 amp Consult Provo City Power Engineering.
- 19.1.3 Bus bars, with provisions for termination lugs as EUSERC 347 are required from the pull section into the service section.

- 19.1.4 Customer shall provide a drawing with dimensions of proposed service equipment.
- 19.1.5 Exterior doors on switchboards must be sealable and hold securely at 90°.
- 19.1.6 Meter panels shall not be hinged on a filler panel. Hinged meter panel must be capable of being opened 90° with meter in place.
- 19.1.7 A barrier is required inside the service section between the CT compartment and the customer pulling section.
- 19.1.8 Conduit and conductor to be supplied, installed, terminated and maintained by owner/contractor per NEC, from the switchboard to the power source supplied by Provo City Power.
- 19.1.9 Service disconnects rated 1000A or more and with a voltage line to ground greater than 150V shall be provided with ground fault protection of equipment (GFPE)